



TDS BIFURCATED FAN

Construction

Direct driven type, double flanged casing, is produced in galvanised steel, the impeller having manually adjustable pitch blades is made of PPG, PAG or pressure-casted aluminium.

Finish

Painting or galvanised after manufacture are normal finishes on all parts

Operating Temperature

-20°C to +180°C

Motors

Totally enclosed Class 'F' motor, to a min. IP54 protection are fitted as standard. Standard motor up to 2.2kW are usually supplied on DOL starting, motor 3.0kW and above are star/delta starting.

Airflow Direction

Air flowing from impeller to motor are fitted as standard. Air flowing from motor to impeller can be supplied upon request.

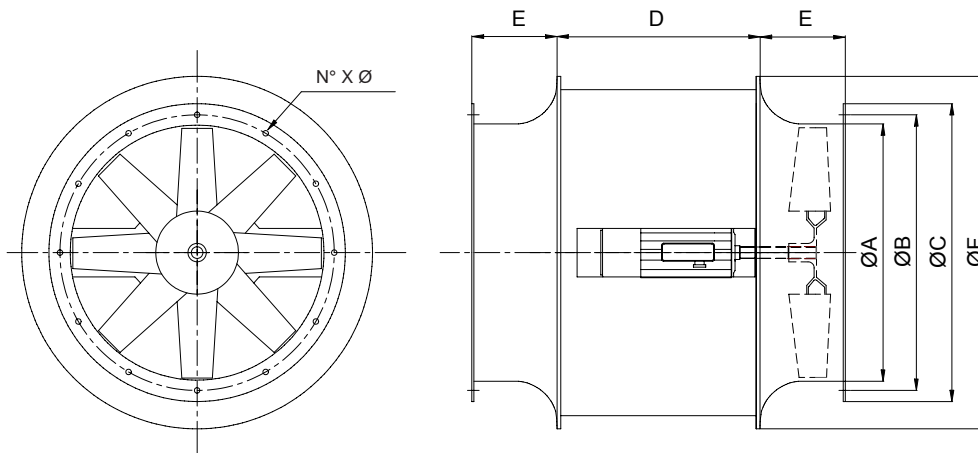

All Dimension in mm.

MODEL	A	B	C	D		E	F	N°	Ø	Weight (kg)	Max. Motor* FrameSize
				Min	Max						
400	393	440	480	270	308	123	592	12	10	35	D90S
450	441	490	530	270	333	137	652	12	10	40	D90L
500	493	540	580	323	365	154	722	12	10	52	D100L
560	562	605	660	345	382	170	810	12	10	64	D112M
630	625	675	730	364	382	190	900	12	10	96	D112M
710	707	755	810	381	507	210	1000	18	12	122	D132M
800	822	856	900	507	593	250	1122	18	12	174	D160M
900	922	956	1000	507	622	280	1252	18	12	225	D180M
1000	1030	1064	1100	593	720	280	1402	24	12	256	D200M

* Motor frame size beyond this range, please consult KRUGER for details --- Weight without motor and impeller.

2 POLES - 2800 RPM

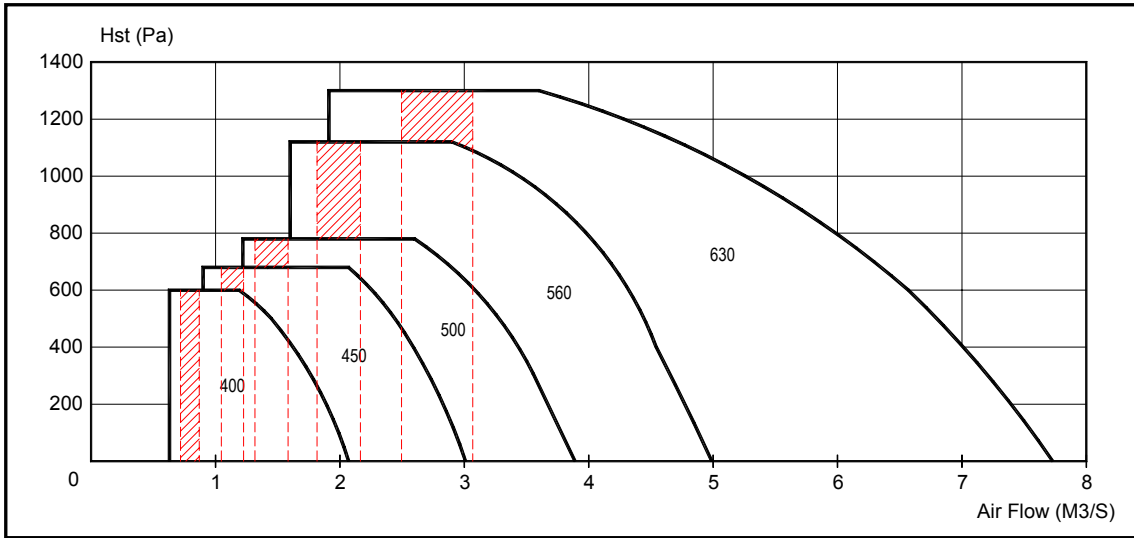

4 POLES - 1420 RPM

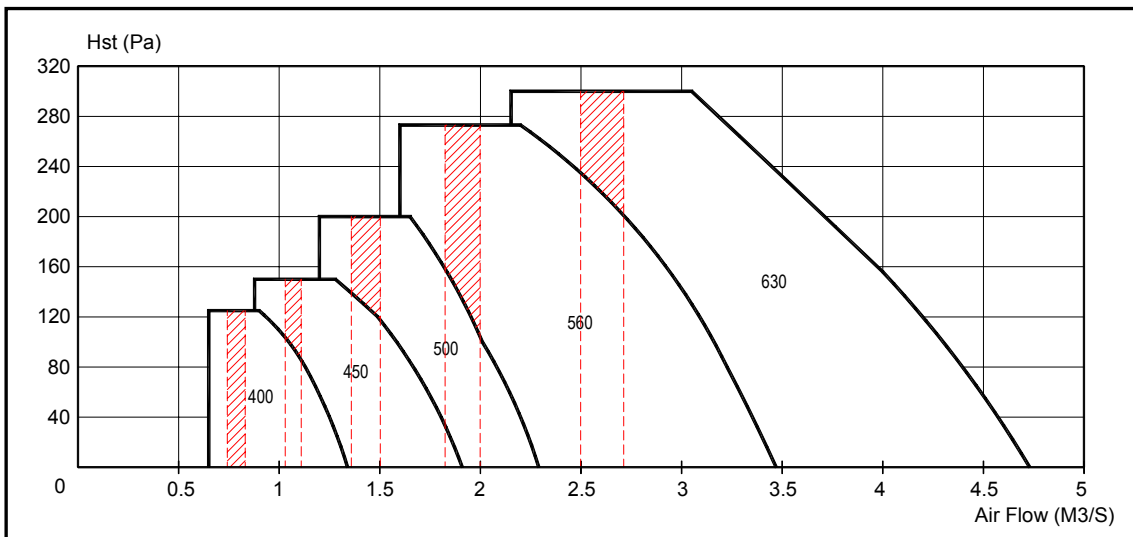

4 POLES - 1420 RPM

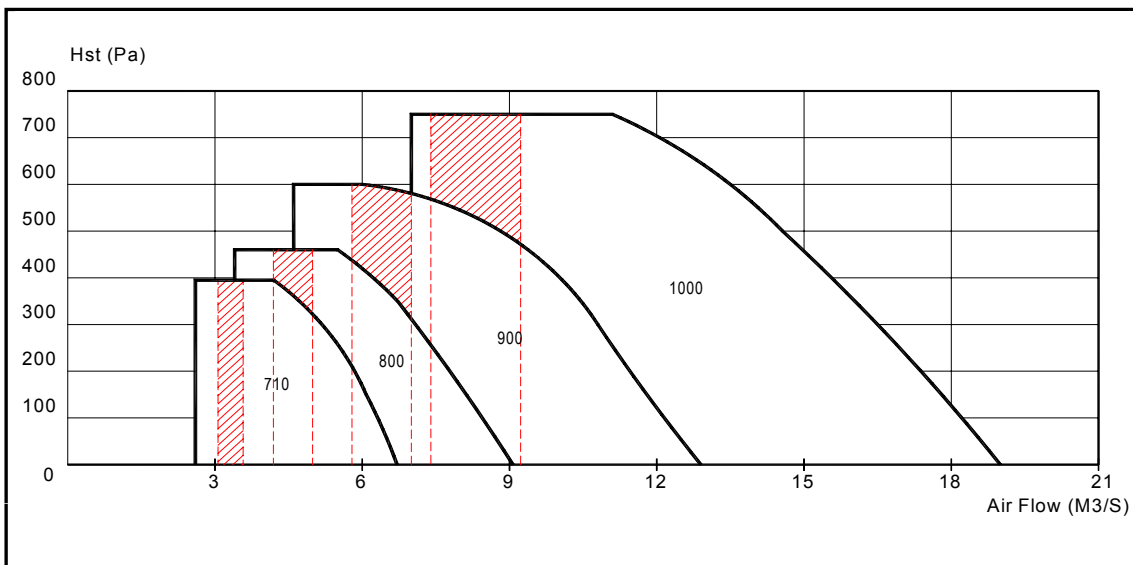

*** Shaded portion is the recommended operating range based on the duct velocity consideration (friction loss of 1 Pa/m)

6 POLES - 900 RPM

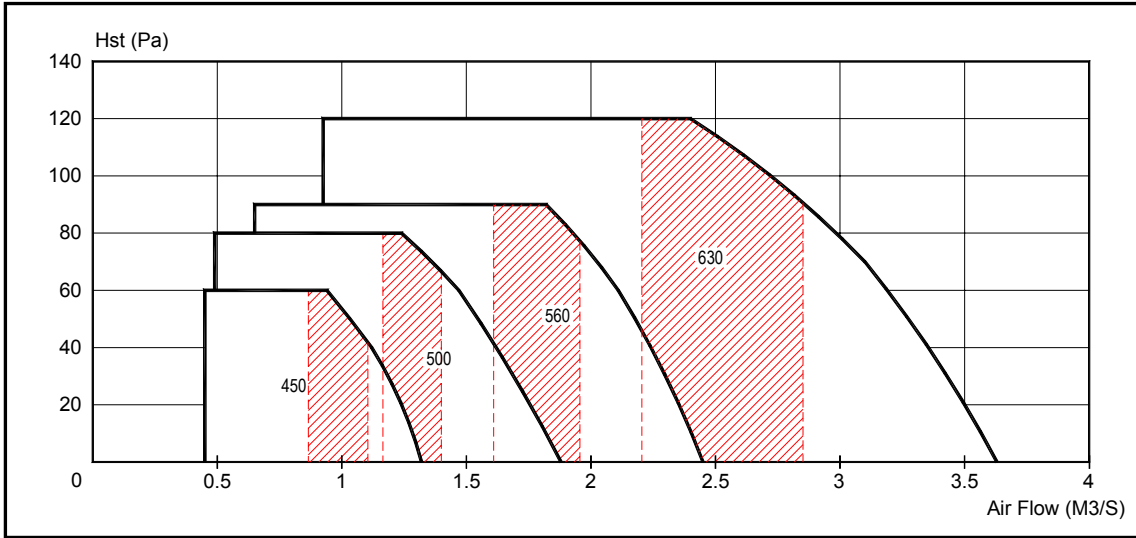

6 POLES - 900 RPM

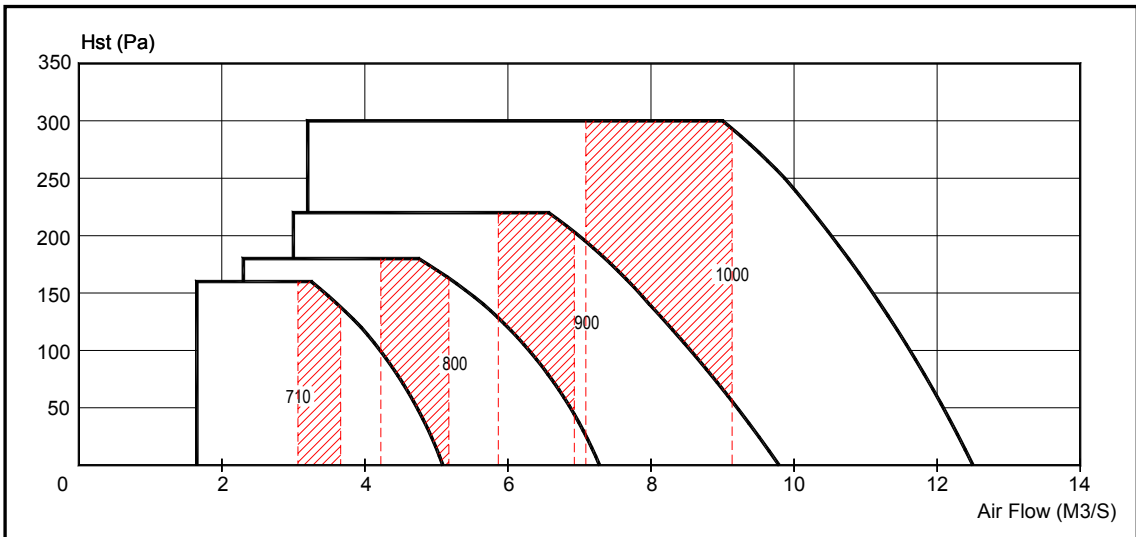

8 POLES - 720 RPM

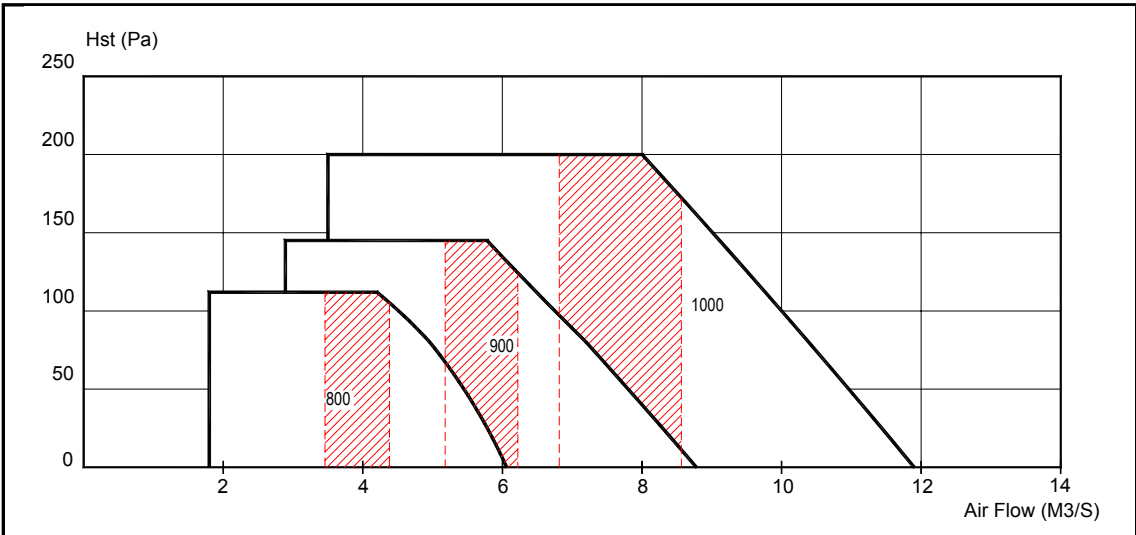

*** Shaded portion is the recommended operating range based on the duct velocity consideration (friction loss of 1 Pa/m)

4 POLES - 1750 RPM

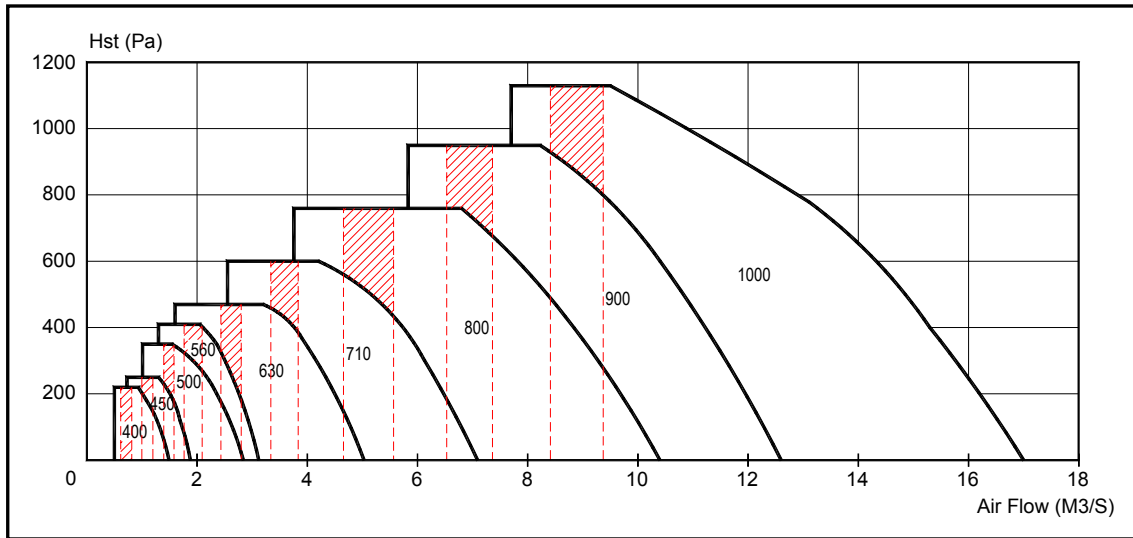

6 POLES - 1150 RPM

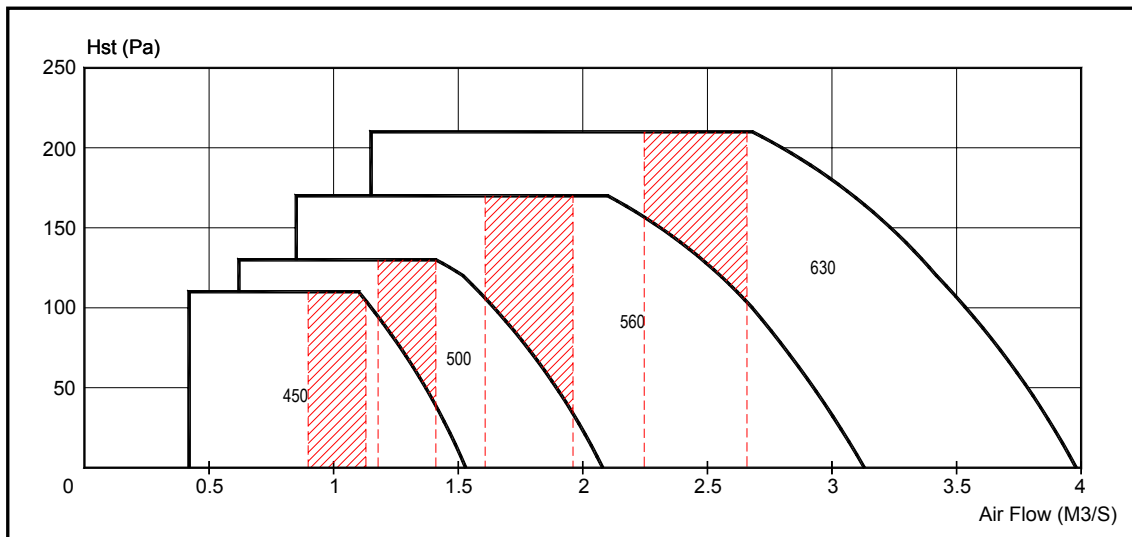

6 POLES - 1150 RPM

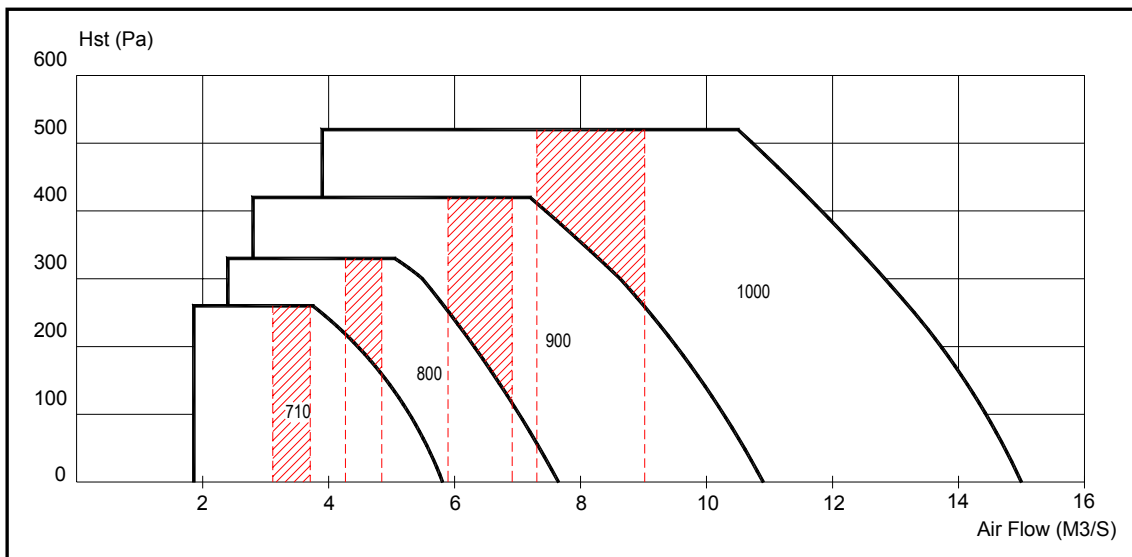

*** Shaded portion is the recommended operating range based on the duct velocity consideration (friction loss of 1 Pa/m)