

KRUGER

General Instructions (Centrifugal Fan)

ADA-BDA-BDB-FDA-KAT ASA-BSB-BSA-FSA



This manual is to guide the users in the proper storage, installation, operation and maintenance procedures to ensure maximum equipment life and trouble-free operation. **HANDLING AND MAINTENANCE SHOULD ALWAYS BE PERFORMED BY EXPERIENCED AND TRAINED PERSONNEL.**

RECEIVING, HANDLING AND STORAGE

Rough handling during shipment and improper storage can cause damage that is not noticeable until the fan is in operation. This can be avoided with proper storage and handling techniques.

Fan should be hoisted with slings placed around the fan housing. Touch up the scratch coated surfaces during lifting, to prevent corrosion to occur at this area. Store the fan in a clean and dry place, preferably indoor to ensure fan shaft, bearing and fan casing are protected against dust and corrosion. Do not store the fan in a location where it will be subjected to vibration. This can cause the internal surface to rub against each other and damage the bearings.

START-UP CHECK LIST

Before putting any fan into initial operation the manufacturer's instruction must be followed. Complete the following checklist to make sure that the fan is ready to run.

- Lock out the primary and all secondary power sources.
- Make sure the foundation or mounting arrangement and the duct connections are adequately designed in accordance with recognized acceptable engineering practices and with the fan manufacturer's recommendations.
- Check and tighten all hold-down (securing) bolts.
- Check the fan assembly and bearings for proper grounding to prevent static electricity discharge.
- Spin impeller to see whether it rotates freely and is not grossly out of balance.
- Inspect impeller for correct rotation for the fan design.
- Check belt drive or coupling alignment, use recommended belt tension.
- Check belt drive for proper sheave selection and make sure they are not reversed.
- Properly secure all safety guards.
- Inlet and Outlet Damper (if any) must maintain 60% air volume, totally closed should be avoided
- Switch on the electrical supply and allow the fan to reach full speed.

Check carefully for :- (1) Excessive vibration
(2) Unusual noise
(3) Proper amperage and voltage values
(4) Proper belt alignment

If any problem is indicated, SWITCH OFF IMMEDIATELY. Lock out the electrical supply, secure the fan impeller if there is a potential for wind milling. (impeller turning due to a draft through the system). Check carefully for the cause of the trouble and correct as necessary.

The fan may now be put into operation but during the first 8 hrs of running, it should be periodically observed and checked for excessive vibration and noise. Checks should be made of motor input current and motor & bearing temperature to ensure that they do not exceed manufacturer's recommendation. After 8 hrs of operation, the fan should be shut down to check the following items :-

- (1) All set screws and hold-down bolts
- (2) Belt drive alignment
- (3) Belt drive tension
- (4) Bearing housing temperature

After 24 hrs of the satisfactory operation, the fan should be shut down, and the drive belt tension should be readjusted to recommended tension.

TROUBLE-SHOOTING

Fan is developing or emitting abnormal or excessive noise

| | Possible cause | Remedy |
|-----------------------|---|--|
| Drive system | <ul style="list-style-type: none"> • Fan or motor sheave not properly tightened onto shaft • Misalign sheaves • Belt hitting Belt Guard • Belts are not tensioned enough and are too loose • Belts too tight • Belts wrong cross section • Belts worn • Belts oily or dirty • Belt guard is not properly fastened • Motor, motor base or fan not securely anchored or Secured | <ul style="list-style-type: none"> • Re-tightened the sheaves • Re-align the sheaves • Check fan & motor sheave alignment & belt tension • Increase the belt tension • Correct belt tension • Change to right type • Replace belts • Clean belts • Tighten the fasteners • Tighten the fasteners |
| Motor | <ul style="list-style-type: none"> • Lean-in cable not secure • Noisy motor bearings • Single phasing a 3 phase motor • Low voltage • Cooling fan striking shroud • Electromagnetic fault in motor • AC hum in motor or relay • Starting relay chatter | <ul style="list-style-type: none"> • Fasten the cable properly • Replace bearing • Check power supply • Check power supply • Check motor assembly • Replace motor |
| Fan Components | <ul style="list-style-type: none"> • Impeller loose on shaft • Impeller unbalance • Impeller not center in inlet or housing • Impeller in contact with inlet cone • Blades rotating close to structural member • Cutoff or other parts loose (rattling during operation) • Cutoff damaged • Cutoff improperly positioned • Impurities or foreign material inside fan housing • Bearing defective or worn out • Bearing loose on bearing support or shaft • Foreign material inside bearing • Fretting corrosion between inner race and shaft • Bearing not sitting on flat surface • Rubbing noise between bearing seal and inner ring • Impeller worn as a result of abrasive or corrosive material moving through passages. • Blades coinciding with an equal number of structural members | <ul style="list-style-type: none"> • Tighten impeller • Balance impeller • Adjust impeller to center of inlet or housing • Correct inlet cone position • Correct the running clearance • Tighten loose parts • Replace cutoff • Reposition cutoff • Clean inside fan and impeller • Replace bearing • Re-tighten bearing • Clean bearing • Replace bearing or shaft • Re-adjust bearing • Replace bearing • Replace impeller |

Fan is vibrating excessively

| | Possible cause | Remedy |
|-----------------|---|--|
| Impeller | <ul style="list-style-type: none"> • Impeller unbalanced due to deposits (dirt or grease) • Impeller unbalanced due to wear | <ul style="list-style-type: none"> • Clean impeller, rebalance the system • Replace impeller |
| Drive | <ul style="list-style-type: none"> • Unbalanced pulleys • Belts may vibrate excessively | <ul style="list-style-type: none"> • Balance the pulley or the system • Proper sheave alignment and adjust to correct belt tension |

Required air volume not achieved

| | Possible cause | Remedy |
|--------------------|--|---|
| Impeller | <ul style="list-style-type: none"> • Impeller not centered with inlet collar(s) • Impeller/inlet dirty or clogged • Improper running clearance • Improper inlet cone to wheel fit • Impeller installed or running wrong direction • Incorrect speed of impeller because of: <ol style="list-style-type: none"> i) Wrong motor speed ii) Belt drive ratio not correct iii) Too high slip of V-belt iv) Wrong calibration of inverter | <ul style="list-style-type: none"> • Adjust the impeller to the center of inlet collar(s) • Clean the impeller or inlet • Change to correct clearance • Adjust to correct fit • Change to correct rotation by changing poles of electrical feed line to motor i) Change motor or belt drive ii) Change belt drive iii) Increase tension of belts iv) Adjust inverter calibration |
| Duct System | <ul style="list-style-type: none"> • Shutters or dampers of the system are closed • Object obstructs fan or duct • Inlet guide vanes are partly close • Dampers closed • Registers closed • Leaks in supply duct • Obstructions near fan outlet or inlet • Sharp elbows near fan outlet or inlet • Improper designed turning vanes • Insulating duct liner loose • Pressure resistance offered by the system higher than the design value • Fluid density higher than the design value • Improper set inlet vane or damper • Actual system is more restrictive (more resistance to flow) than expected • Obstructed fan outlet inlets Elbows, cabinet walls or other obstructions restrict air flow. Inlet obstructions cause more restrictive systems but do not cause increased negative pressure readings near the fan inlet(s) Fan speed may be increased to counteract the effect of restricted fan inlet(s). Caution! Do not increase speed beyond the fan manufacturers recommendations • No straight duct at fan outlet (Fans which are normally used in duct system are tested with a length of straight duct at fan outlet. If there is no straight duct at the fan outlet, decreased performance may result. If it is not practical to install a straight section of duct at the fan outlet, the fan speed may be increased to overcome this pressure loss. Caution! Do not increase fan speed beyond the fan manufacturers recommendations.) • Projections, dampers or other obstruction in a part of the system where air velocity is high • Obstructions in high velocity air stream | <ul style="list-style-type: none"> • Open damper or IVC • Clear obstructed ducts • Open grill/diffuser damper • Open Damper • Open Register • Seal the Leakage • Clear obstruction • Redesign and change elbow • Redesign and change vanes |

Fan does not start or operate

| | Possible cause | Remedy |
|--------------------------|--|---|
| Electrical Supply | <ul style="list-style-type: none"> Blown fuses Electricity turned off Wrong voltage Failure of one or two phases Low voltage, excessive line drop or inadequate wire size | <ul style="list-style-type: none"> Check fuses/circuit breakers Check for switched off or disconnected Check for correct power supply Check for correct power supply Check for correct wire size |
| Motor | <ul style="list-style-type: none"> Motor not correctly connected Load inertia too large for motor Motor protection unit or switch are stopping as temperature are too high Motor too small and overload protector has broken circuit | <ul style="list-style-type: none"> Connect the motor according to the motor label Change motor Reduce temperatures, check and change insulation class, increase motor rating Change motor |
| Drive System | <ul style="list-style-type: none"> Broken belts Loose pulleys | <ul style="list-style-type: none"> Replace belt Tighten pulley |

Excessive air flow

| | Possible cause | Remedy |
|--------------------|---|--|
| Fan | <ul style="list-style-type: none"> Excessive rotational fan speed | <ul style="list-style-type: none"> Reduce fan speed |
| Duct System | <ul style="list-style-type: none"> Pressure resistance offered by the system lower than the design value | |
| Gas Density | <ul style="list-style-type: none"> Gas density higher than the design value | |

High power absorption

| | Possible cause | Remedy |
|----------------------|--|--|
| Impeller | <ul style="list-style-type: none"> Air flow already rotating in the opposite direction to the fan rotation direction Backward curved impeller installed backwards | |
| Motor | <ul style="list-style-type: none"> Faults in the motor windings Motor power supply voltage lower than the value indicated on the identification plate | <ul style="list-style-type: none"> Replace motor Check with motor supplier |
| Fan | <ul style="list-style-type: none"> Forward curved or backward blade fan operating below design pressures. | |
| System | <ul style="list-style-type: none"> Oversized ductwork Filter(s) left out Access door are open Face and by-pass dampers oriented so coil dampers are open at same time by-pass dampers are open | <ul style="list-style-type: none"> Redesign ductwork Add in filter(s) Close access door |
| Gas Density | <ul style="list-style-type: none"> Calculated horsepower requirements based on light gas (eg. High temperature) but actual gas is heavy (eg. Cold start up) | |
| Fan selection | <ul style="list-style-type: none"> Fan not selected at efficient point of rating | <ul style="list-style-type: none"> Check selection |

GUIDELINES FOR CENTRIFUGAL FAN INSTALLATION

Improper installation with inlet or discharge configurations may result in reduced performance. Restricted or unstable flow at the fan inlet can cause pre-rotation of incoming air or uneven loading of the fan wheel yielding large system loss and increase sound levels. Free discharge or turbulent flow in the discharge ductwork will also result in system effect losses.

Ducted Inlet Installation

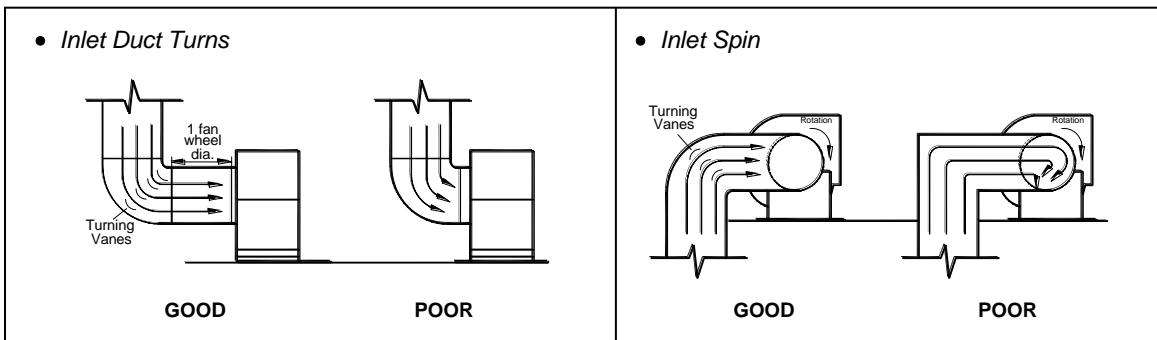

Ducted Outlet Installation

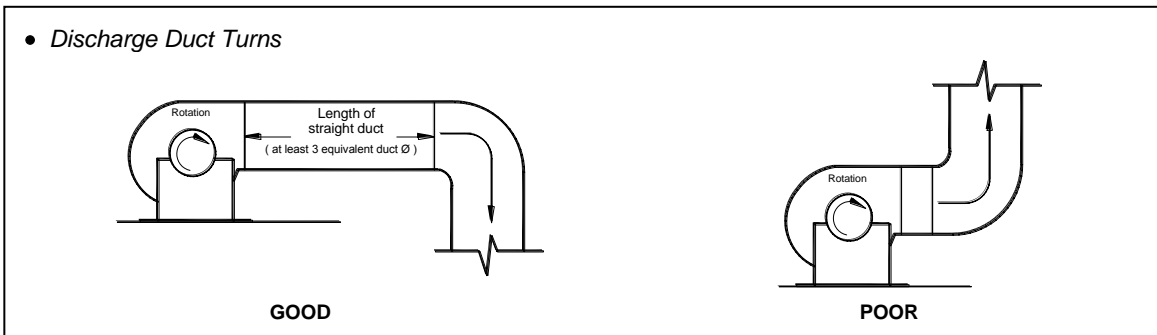

Non-Ducted Installation

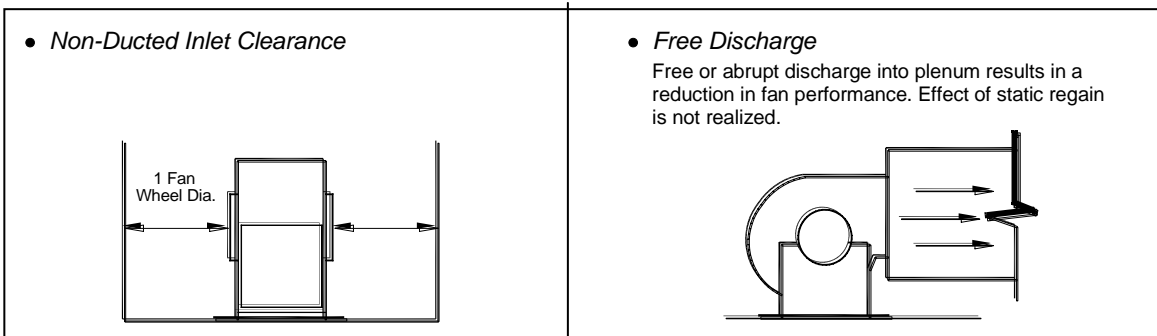

Installation Method – DIDW Centrifugal Fan

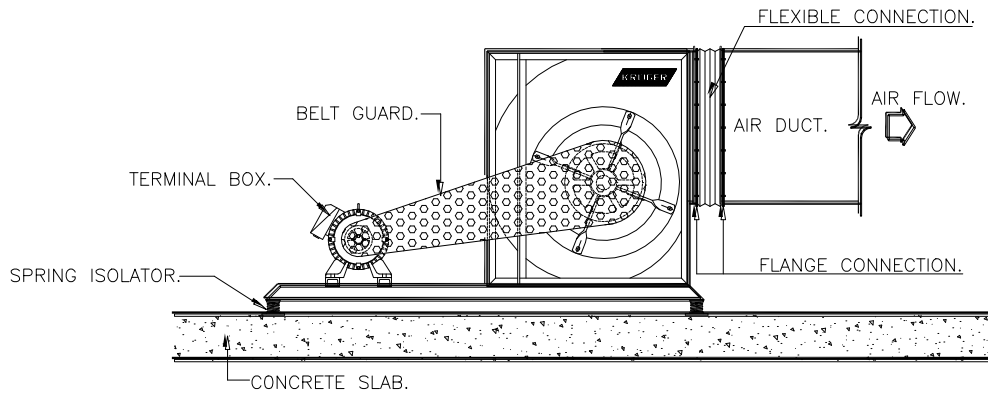

Fig.1 - Floor Type

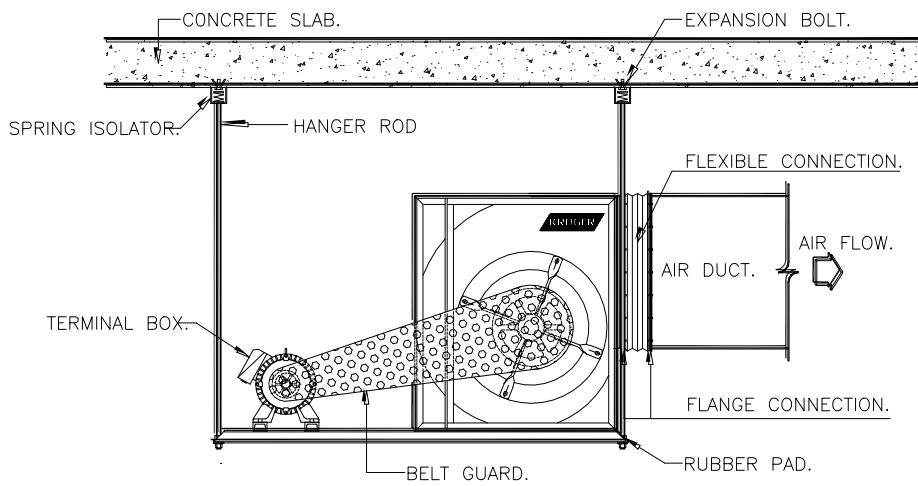
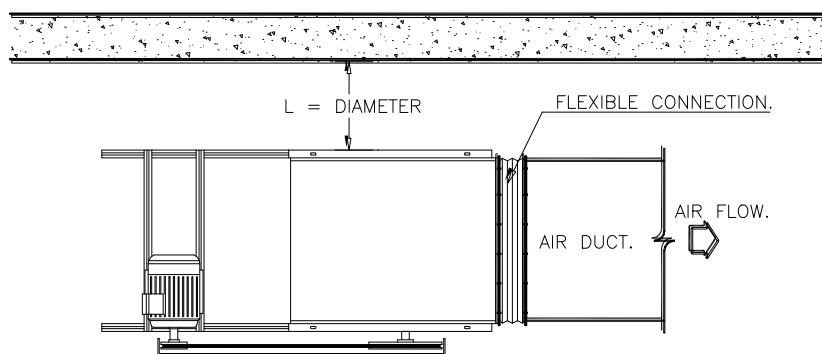

Fig.2 – Ceiling Type



Top View

Installation Method – SISW Centrifugal Fan

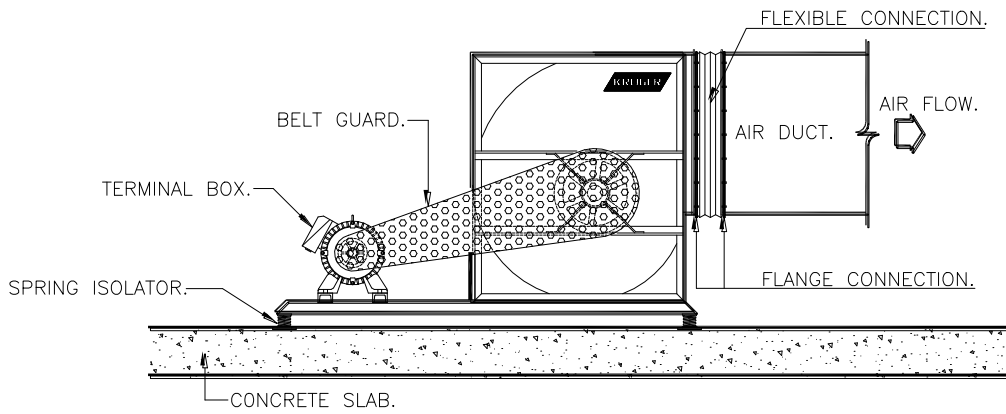

Fig. 3 - Floor Type

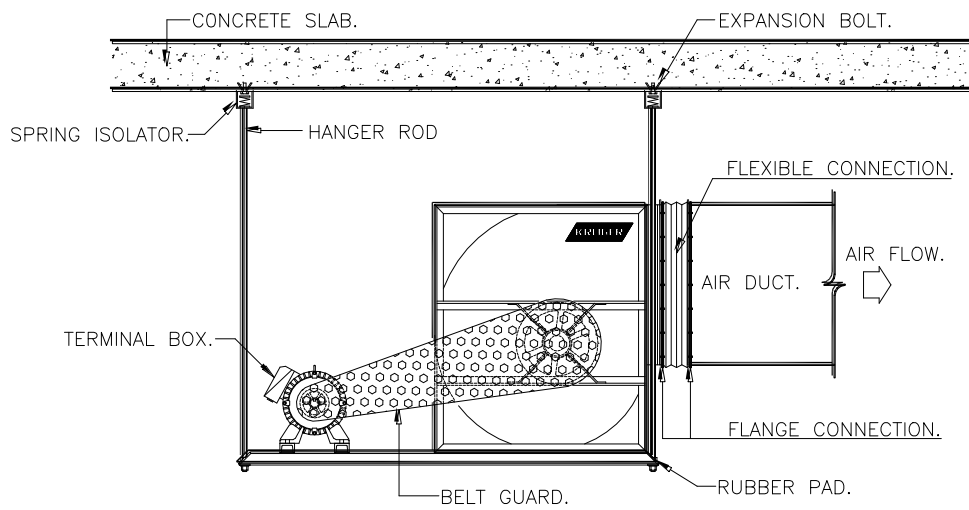
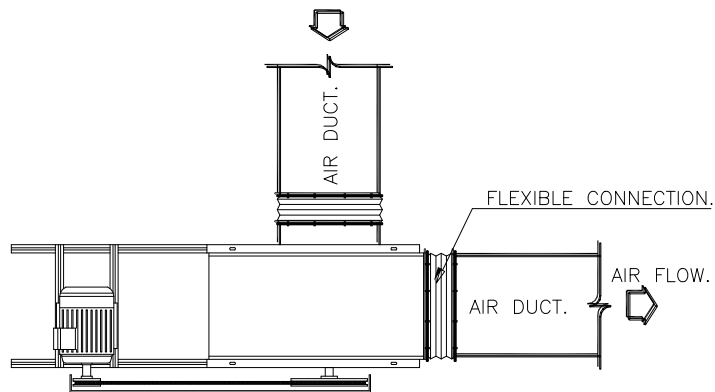

Fig. 4 - Ceiling Type



Top View

V-BELT DRIVE INSTALLATION

- Remove the protective coating from the end of the fan shaft and assure that it is free of nicks and burrs.
- Check fan and motor shafts for parallel and angular alignment.
- Slide sheaves on shafts – do not drive sheaves on as this may result in bearing damage.
- Align fan and motor sheaves with a straight-edge or string and tighten.
- Place belts over sheaves. Do not pry or force belts, as this could result in damage to the cords in the belts.
- Adjust the tension until the belts appear snug. Run the unit for a few minutes (see section on unit start-up) and allow the belts to “set” properly.
- Switch off the fan, adjust the belt tension by moving the motor base. When in operation, the tight side of the belts should be in a straight line from sheave to sheave with a slight bow on the slack side.

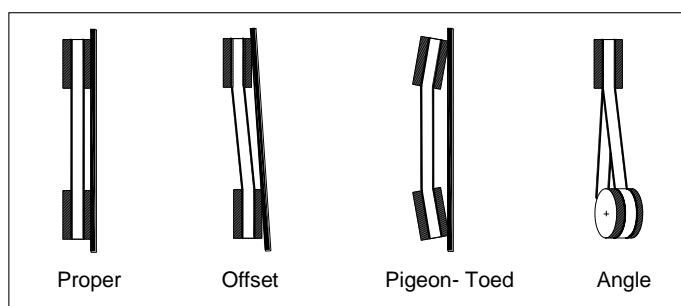
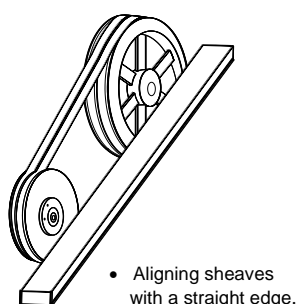

BELT TENSION

Proper belt tension is important for long belt life. Too much tension puts excessive loads on the belts and the bearings, reducing the lives of both components. Not enough tension allows belt slippage which generates heat and drastically reduces the life of the belt.

Belt tensioning gauges can be used to determine whether the belts are tensioned properly. A chart that comes with the gauge specifies a range of force required to deflect the belts a given amount based on the centre distance of the sheaves and the belt cross section. The belts are properly tensioned when the force required to deflect the belt, the specified amount falls within this range.

If a belt tensioning gauge is not available, re-tension the belts just tight enough so that they do not squeal when starting the fan. A short “chirp” is acceptable; a squeal lasting several seconds or longer is not acceptable.

Before starting the fan after tensioning the belts, recheck the alignment and realign the sheaves if necessary. New belts may stretch a little at first, so recheck belt tension after a few days of operation.

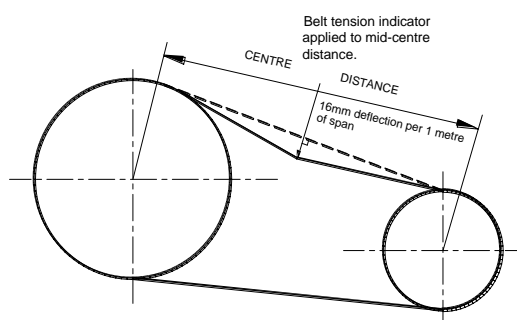

Tensioning Forces

| Belt Section | Force required to deflect belt 16mm per metre of span | | |
|--------------|--|------------|-------------------------|
| | Small Pulley Diameter (mm) | Newton (N) | Kilogram force (Kgf) |
| SPZ | 56 - 95 | 13 - 20 | 1.3 - 2.0 |
| | 100 - 140 | 20 - 25 | 2.0 - 2.5 |
| SPA | 80 - 132 | 25 - 35 | 2.5 - 3.6 |
| | 140 - 200 | 35 - 45 | 3.6 - 4.6 |
| SPB | 112 - 224 | 45 - 65 | 4.6 - 6.6 |
| | 236 - 315 | 65 - 85 | 6.6 - 8.7 |
| SPC | 224 - 335 | 85 - 115 | 8.7 - 11.7 |
| | 375 - 560 | 115 - 150 | 11.7 - 15.3 |
| A | 80 - 140 | 10 - 15 | 1.0 - 1.5 |
| B | 125 - 200 | 20 - 30 | 2.0 - 3.1 |

BEARING LUBRICATION

Fan equipped with deep grooved ball bearing inserted in rubber damper has sufficient high grade grease sealed in at the time of manufacture, there is no need for replenishment while in use at normal speed & normal condition.

Fan equipped with deep grooved ball bearing inserted in pillow block also has sufficient high grade grease sealed in at the time of manufacture, there is no need for replenishment while in use at normal speed & normal condition. The pillow block housing has lubrication point suitable for lubricating when the bearing operating temperature exceeding its nominal of 70 degree, or the bearing is used in very dusty or damp or high contamination environment.

Fan equipped with spheriodical roller bearing assembly in the plummer block housing has lubrication point when the life of the grease is expectancy. The bearings must be greased at regular intervals in order to attain the maximum permissible life of the bearing under more severe operating conditions.

The re-lubricating interval depends on the operating temperature, relevant operating conditions speed and the type of grease used should be set by the operator.

The lubricating interval may be determined from the following diagram.

Caution: Do not over-lubricate. This is a major cause of bearing failure. Make sure dirt and contaminants are not introduced when adding grease.

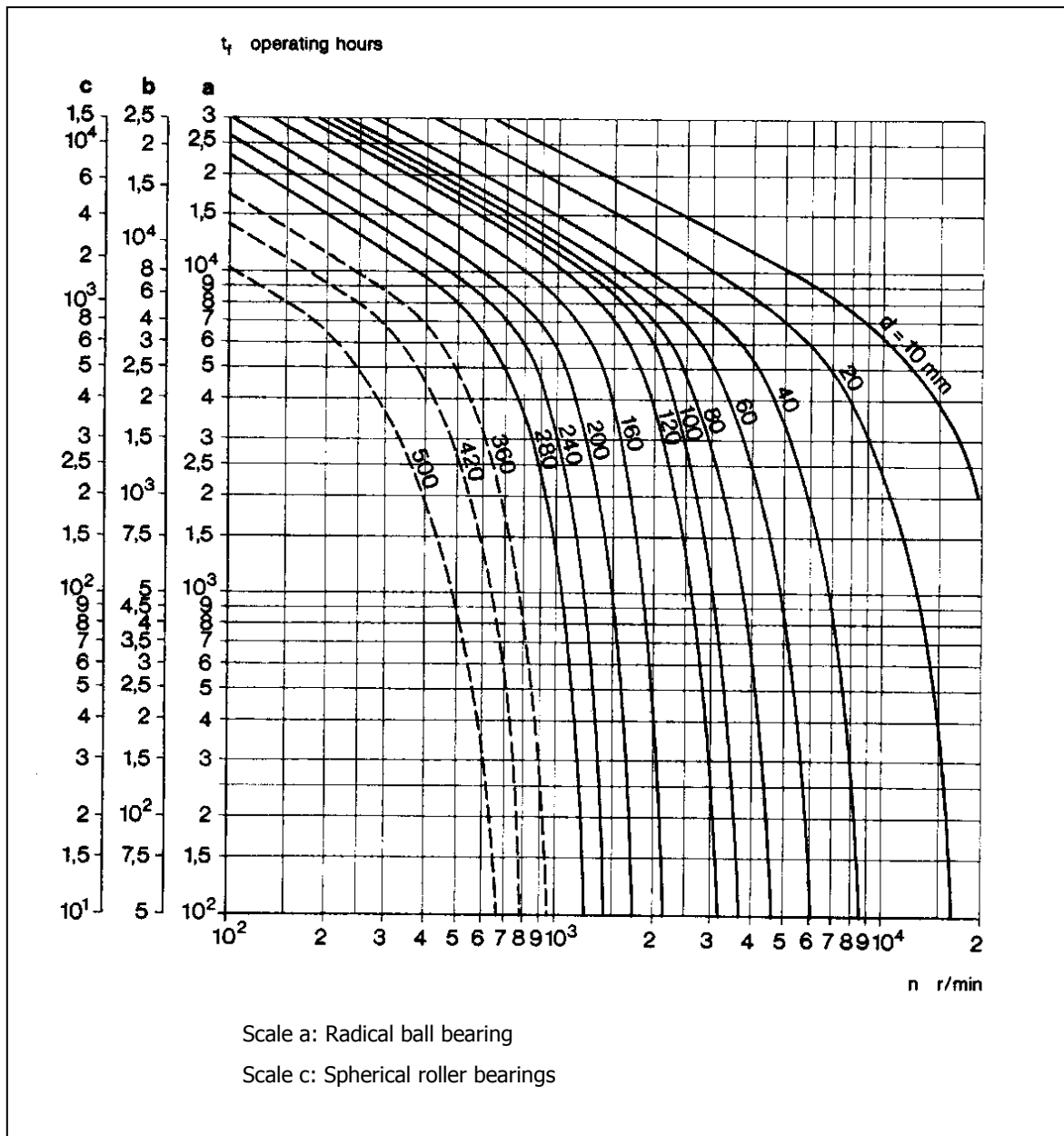

| Type of bearing | Type of grease |
|---------------------------------|---------------------------|
| FYH Deep Groove Ball Bearing | Alvania Grease#2/Gold #3A |
| NSK Deep Groove Ball Bearing | Alvania Grease #3 |
| SKF Deep Groove Ball Bearing | SKF Grease LGMT 3 |
| SKF Spheriodical Roller Bearing | SKF Grease LGMT 3 |

VIBRATION ISOLATOR INSTALLATION

- Choose proper isolator
(Isolator can be selected from Kruger selection programme)
- Adjust deflection based on the selected isolator.
- Maintain the operating / free height at the same level through step 2.
(The entire assembly must be levelled)
- Check all the deflection and operating / free height is properly maintained.

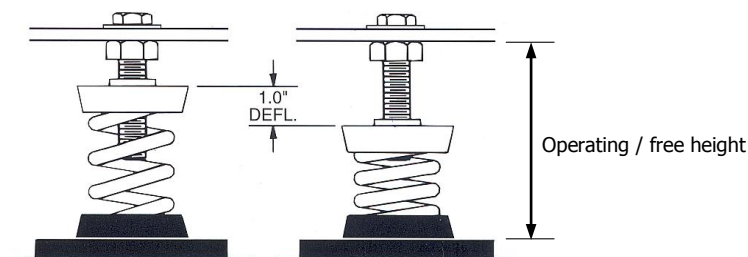

ROUTINE MAINTENANCE

Maintenance should always be performed by experienced and trained personnel. Do not attempt any maintenance on a fan unless the electrical supply has been locked out or tagged out and the impeller has been secured.

Under normal circumstances, handling clean air, the system should require cleaning only about a Year. However, the fan and system should be checked at regular intervals to detect any unusual accumulation.

The fan impeller should be specially checked for build-up of material or dirt which may cause an Imbalance with resulting undue wear on bearings and belt drives. A regular maintenance program should be established as needed to prevent material build-up.

Periodic inspection of the rotating assembly must be made to detect any indication of weakening of the rotor because of corrosion, erosion, or metal fatigue.

THE KRUGER GROUP

SINGAPORE

Kruger Ventilation Industries Pte Ltd

No. 17, Tuas Avenue 10
Singapore 639141
Tel. +65 68611577 – Fax +65 68613577
Email: mktg@krugerasia.com

MALAYSIA

Kruvent Industries (M) Sdn Bhd

Lot 8, Jalan Perusahaan 2 Batu Caves
Industrial Area, 68100 Batu Caves Selangor
Tel. +603 61888293 – Fax +603 61898843
Email: mktg@kruger.com.my

BEIJING

Beijing Kruger Ventilation Co. Ltd

No. 1A South Industry Area
Beijing Economical And Technological
Development Area, Beijing China 100176
Tel. +86 10-67881366 – Fax +86 10-67880566
Email: krugerbj@krugerchina.com

HONG KONG

Kruger Ventilation (Hong Kong) Limited

Flat C, 9/F,
Yeung Yiu Chung (No. 8) Industrial Building,
20 Wang Hoi Road,
Kowloon Bay, Kowloon, Hong Kong
Tel. +852 22469182 – Fax +852 22469187
Email: cfyau@kruger.com.hk

WUHAN

Wuhan Kruger Ventilation Co. Ltd

Xincheng Road 10, South Dongwu Ave,
Dongxihu District, Wuhan, Hubei, P.R.China 430040
Tel. +86 27-83248840 – Fax +86 27-83261886
Email: whkruger@krugerchina.com

PHILIPPINES

Kruger M&E Industries Corporation

FAPIC Compound, E. Rodriguez Ave.
Tunasan, Muntinlupa City, Philippines 1773
Tel. +63 2-8622891-97 – Fax +63 2-8621287
Email: mktg@krugerph.com

INDONESIA

P.T. Kruger Ventilation Indonesia

JL. Teuku Umar No.20
Karawaci – Tangerang 15115, Indonesia
Tel. +62 21-5512288/5513557 – Fax +62 21-5513502
Email: mktg@krugerindo.co.id

KOREA

Neomate Technology & Consulting Co. Ltd

2-1010, Ace High City B/D, Mullae-dong 3-ga
Yeongdeungpo-gu, Seoul, Korea, 150-972
Tel. +82 2-26792052 – Fax +82 2-26792174
Email: neomatetnc@chol.com

DUBAI

Kruger Ventilation Industries, Gulf Branch

Jebel Ali Free Zone Area (JAFZA)
Near Roundabout 8, Warehouse No. RA08FC05
P.O. Box No. 262949
Tel. +971 4-8832017 – Fax +971 4-8832018
Email: johncs@krugerasia.com

SINGAPORE

Kruger Engineering Pte Ltd

No. 17, Tuas Avenue 10
Singapore 639141
Tel. +65 68631191 – Fax +65 68631151
Email: mktg@krugerasia.com

THAILAND

Kruger Ventilation Ind. (Thailand) Co. Ltd

30/105 Moo 1 Sinsakorn Industrial Estate
Chetsadawithi Road, Khok Kham Mueng,
Sakuthsakorn 74000, Thailand
Tel. +662 1050399 – Fax +662 1050370-2
Email: mktg@kruger.co.th

GUANGZHOU

Guangzhou Kruger Ventilation Co. Ltd

No. 9 Huahui Road, Huashan
Huadu, Guangzhou, P.R. China
Tel. +86 20-86786070 – Fax +86 20-86786001/86786500
Email: gzkruuger@krugerchina.com

SHANGHAI

Shanghai Kruger Ventilation Co. Ltd

No. 500 Yuanguo Road, Anting, Jiading,
Shanghai 201814, P.R. China
Tel. +86 21-69573266 – Fax +86 21-69573296
Email: shkruuger@krugerchina.com

TAIPEI

Kruger Ventilation (Taiwan) Co. Ltd

No. 157, Ping-an Rd, Hengfeng Village,
Dayuan Shiang Taoyuan County 337, Taiwan (ROC)
Tel. +886 3-3859119 – Fax +886 3-3859118
Email: kyyang@krugertwn.com.tw

AUSTRALIA

S&P-Kruger Australia Pty Ltd

2 Cunningham St
Moorebank N.S.W. 2170
Tel. +61 2-98227747 – Fax +61 2-98227757
Email: info@sandpkruger.com.au

INDIA

Kruger Ventilation Industries (India) Pvt Ltd

Kruger Centre, Mumbai-Nasik Highway,
Atgaon, Shahapur, Thane 421304, Maharashtra, India
Tel. +91 9860730999 – Fax +91 2527240075
Email: sales@krugerindia.com

VIETNAM

Kruger Ventilation Industries Pte Ltd (Vietnam Representative Office)

4th Floor, HHM Office Building, 157-159 Xuan Hong St,
Tan Binh Dist, Hochiminh City, Vietnam
Tel. +84 8-6-2968123 – Fax +84 8-6-2968124
Email: mktg@krugervn.com